



# Bees and Their Hives

NAME: .....

CLASS: .....

DATE: .....



## Basic

1) Tessellate using the following shapes. (Use at least four more of each shape in your tessellation.)

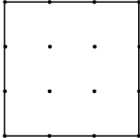
a)  .....

.....

.....

.....

.....

.....

.....

.....

.....

.....

.....

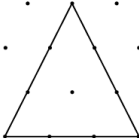
b)  .....

.....

.....

.....

.....

.....

.....

.....

.....

.....

.....

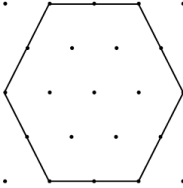
c)  .....

.....

.....

.....

.....

.....

.....

.....

.....

.....

.....



# Bees and Their Hives

NAME: .....

CLASS: .....

DATE: .....

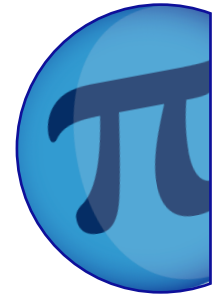

## Core

1) Tessellate using the following shapes. (Use at least four more of each shape in your tessellation.)

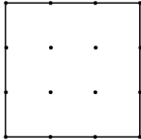
a)  .....

.....

.....

.....

.....

.....

.....

.....

.....

.....

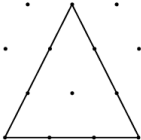
b)  .....

.....

.....

.....

.....

.....

.....

.....

.....

.....

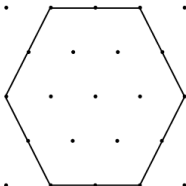
c)  .....

.....

.....

.....

.....

.....

.....

.....

.....



# Bees and Their Hives

Core

2) Calculate the volume of the prism below.

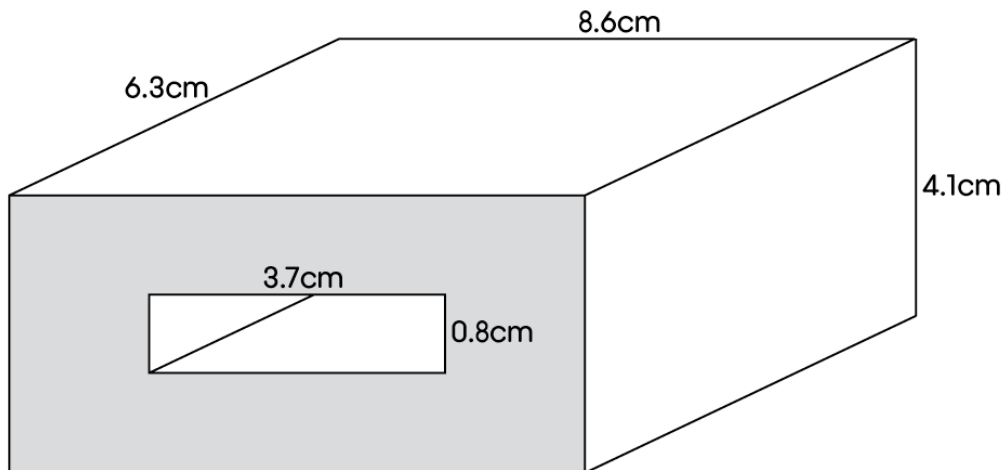



# Bees and Their Hives

NAME: .....

CLASS: .....

DATE: .....

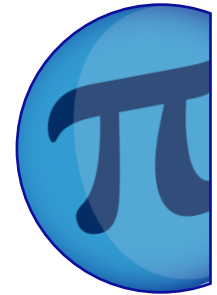

## Advanced

1) The area of a square is  $l^2$ , where  $l$  is the length of a side.

Calculate the area of the following squares:

Length of side	Area
1cm	
2cm	
4cm	
8cm	

2) The area of an equilateral triangle is  $\frac{l^2\sqrt{3}}{4}$ , where  $l$  is the length of a side.

Calculate the area of the following equilateral triangles:

Length of side	Area
1cm	
2cm	
4cm	
8cm	

3) The area of a hexagon is  $\frac{3\sqrt{3}}{2}l^2$ , where  $l$  is the length of a side.

Calculate the area of the following hexagons:

Length of side	Area
1cm	
2cm	
4cm	
8cm	



# Bees and Their Hives

## ANSWERS

### Basic

1) a)

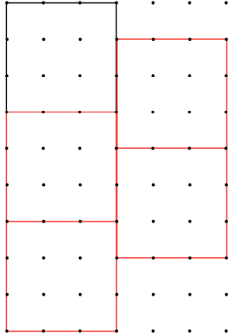

b)

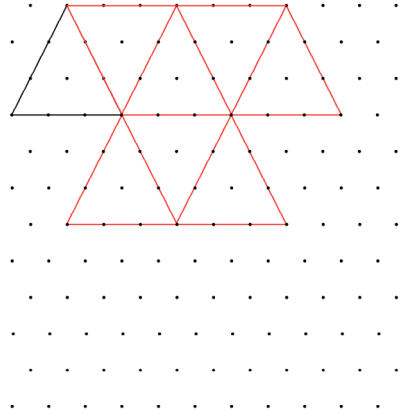

c)

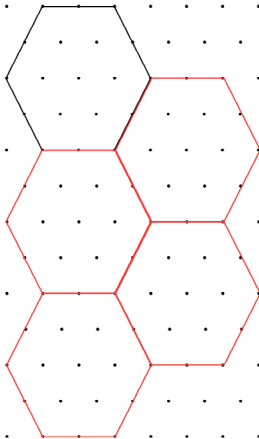

### Core

1) a)

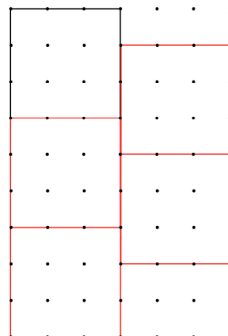

b)

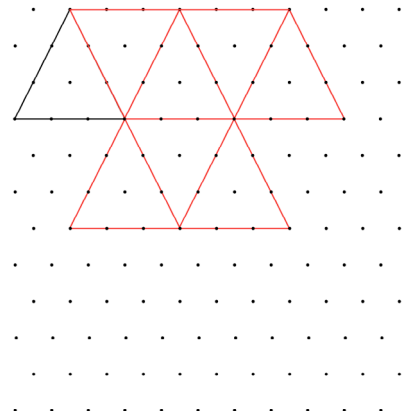



# Bees and Their Hives

## ANSWERS

### Core

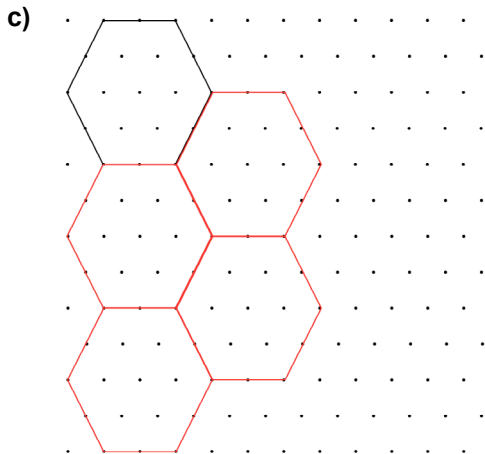

2) Volume of prism =  $203.49\text{cm}^3$

### Advanced

#### 1) Areas of squares:

Length of side	Area
1cm	$1\text{cm}^2$
2cm	$4\text{cm}^2$
4cm	$16\text{cm}^2$
8cm	$64\text{cm}^2$

#### 2) Areas of equilateral triangles:

Length of side	Area
1cm	$0.43\text{cm}^2$
2cm	$1.73\text{cm}^2$
4cm	$6.93\text{cm}^2$
8cm	$27.71\text{cm}^2$

#### 3) Areas of hexagons:

Length of side	Area
1cm	$2.60\text{cm}^2$
2cm	$10.39\text{cm}^2$
4cm	$41.57\text{cm}^2$
8cm	$166.28\text{cm}^2$